

Measures the characteristics of dough during proofing

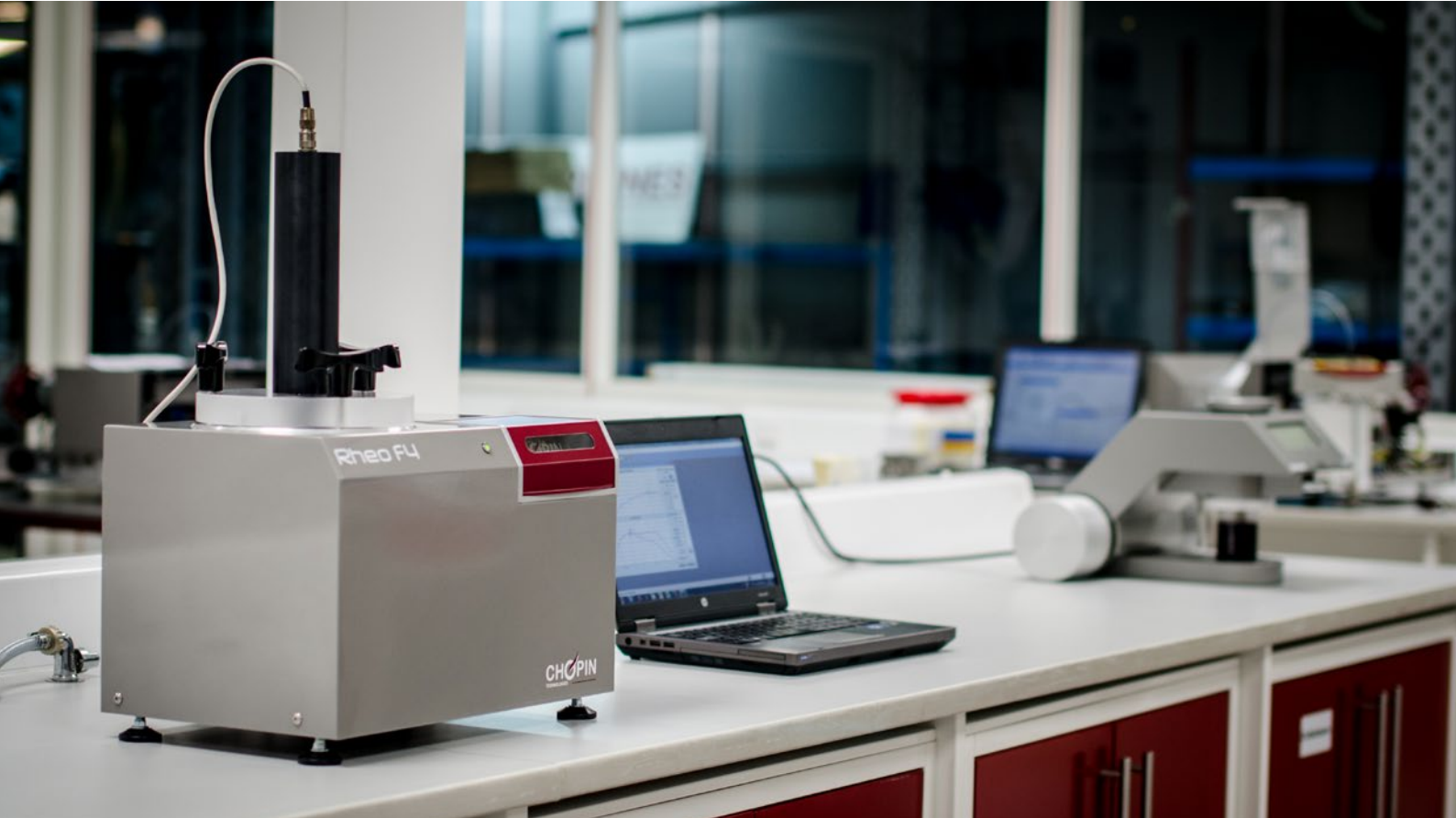

Comprehensive

- Measures within a single test:
 - The dough development.
 - The production of gas due to yeast action.
 - The porosity of the dough.
 - The tolerance of the dough during proofing.

Versatile

- Analyzes all types of yeast dough due to the fact that the protocol can be customized.

Simple

- Automated testing and monitoring via PC software.

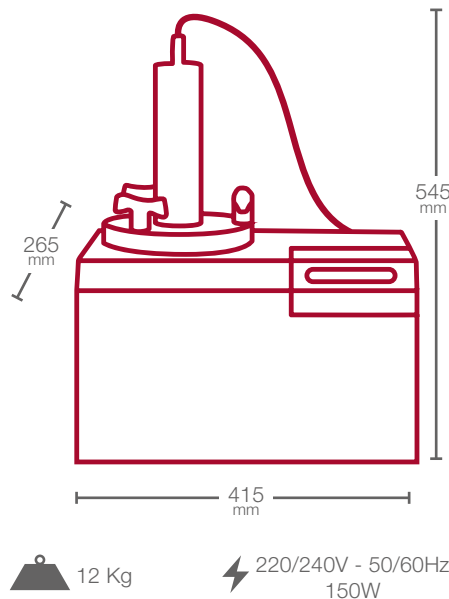

Test time : **3 heures 30**
Operator time : **15 minutes**



keydiagnostics

T: 02 8212 4074 F: 02 9423 6992
info@keydiagnostics.com.au
www.keydiagnostics.com.au
PO Box 1038, Gymea, NSW, 2227

Measurement principle

The Rheo F4 measures the pressure every 45 seconds in the thermostatically controlled, airtight tank that contains the dough. In a direct cycle (red curve), the device measures total gas production (yeast action). In an indirect cycle (blue curve), it measures gas retention i.e. the porosity of the dough.

A sensor in the top of the dough shows its development and stability so that the optimum baking time can be determined.



Results from the dough development curve:

- Hm: maximum development reached by the dough, correlated with bread volume.
- T1: time required for maximum development, in relation to yeast activity.
- T2 – T'2: relative stability time at the maximum point, in relation to dough tolerance and the optimum time for products to be placed in the oven.

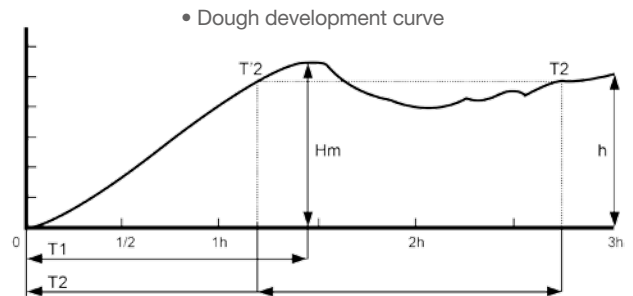

Results from the gas production curve:

- H'm: maximum height of the curve.
- T1: time required to reach H'm.
- Tx: time of appearance of porosity in the dough i.e. time when the dough begins to give off CO₂.
- Total volume: total volume of gas given off in ml.
- Total volume of CO₂ lost: total volume of carbon dioxide in ml. that the dough has allowed to escape during proofing (A2).
- Volume of retention: volume of carbon dioxide in ml. still retained within the dough at the end of the test (A1).

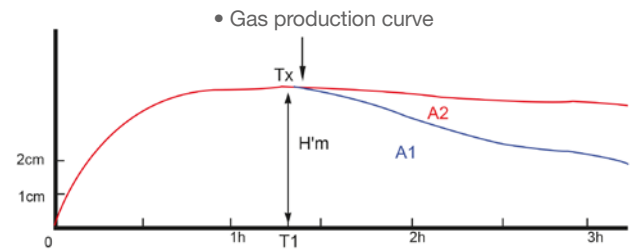

The gas production curve enables the user to determine the retention coefficient R (the comparison in % between the volume retained within the dough and the total volume of gas produced during the test).

Results

The test is fully automated and delivers all calculations. This allows the data from several samples to be compared to determine product conformity at the end of analysis and also to precisely evaluate the effect of an ingredient on the dough.

The results are backed up automatically and can be printed in the form of a customizable analysis certificate.

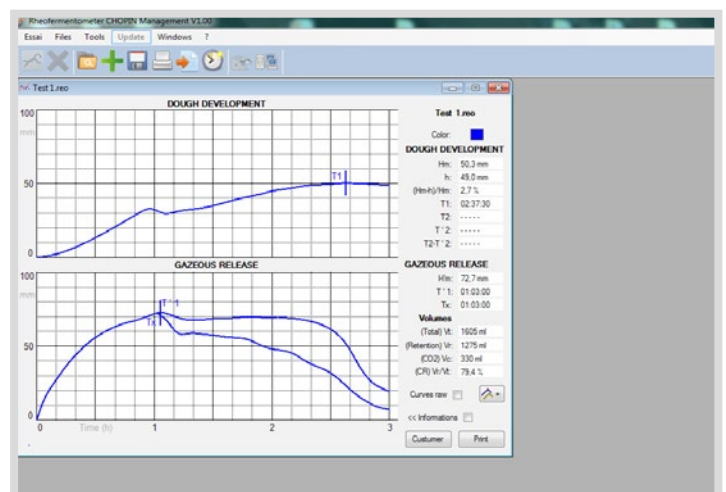

Applications

Evaluate the impact of additives on your recipes

• Example 1: Amylase

The use of amylase improves the fermentative and rheological capacity of flour. The Rheo F4 demonstrates this precisely: increase in dough volume and greatly increased production of CO₂ (from 800 to 1000ml.).

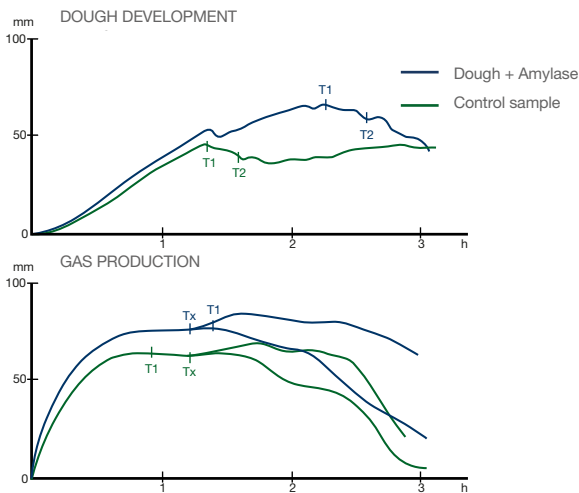

• Example 2: Vital gluten

The use of vital gluten is very common in the cereal industry. All vital glutes do not have the same effect. The Rheo F4 allows their performance to be evaluated.

In the example below, sample A increases the final volume of the product and delays the appearance of porosity in the dough. Sample B removes all porosity from the dough.

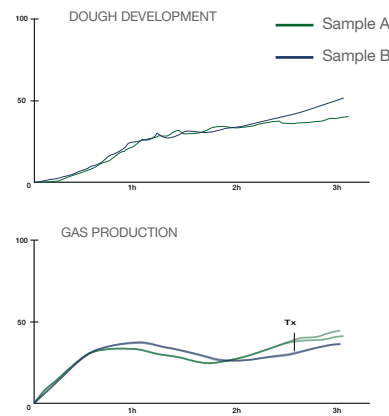

Analyze the proofing properties of frozen dough

Freezing cycles have a great effect on the proofing properties of dough. The Rheo F4 can precisely evaluate the proofing properties of dough after freezing.

In the example below, the frozen sample has development (not shown) and gas production inferior to the control sample.

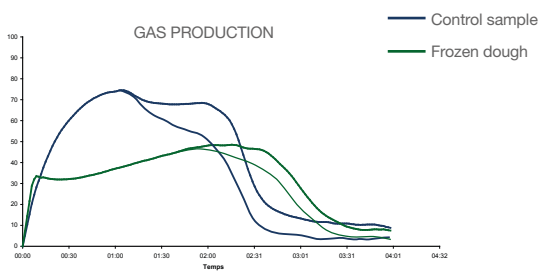

Analyze the properties of gluten free recipes

Gluten is mainly responsible for the retention of gas produced during proofing. Gluten free products are therefore subject to particularly complex problems of volume and performance during baking. The Rheo F4 can analyze these products and is an invaluable aid to their development.

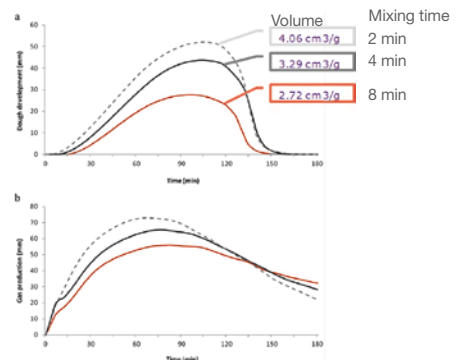

Monitor of consistency in production

Because it is possible to compare an ongoing test instantly with a reference, the user can immediately judge the quality of the flours, production consistency and exactly locate any defects in the dough.

Evaluate the impact of salt reduction

Salt regulates the activity of yeasts by increasing osmotic pressure. Without salt, their activity is very intense but also very brief. The effects of a reduction in salt content in a recipe are clearly highlighted by the Rheo F4.

Other applications

- Determination of the optimum baking time.
- Monitoring the activity of fresh and dried yeasts.
- Analysis of complete formulas containing sugar, fats, etc.
- Analysis of high fiber recipes.
- Analysis of durum wheat semolina.
- Analysis of the effects of additives such as cysteine, ascorbic acid, vitamins, etc.



Advantages

Comprehensive

- Measure with a single test:
 - Dough development.
 - Gas production by the yeast.
 - Porosity / permeability of the dough.
 - Tolerance of the dough during proofing.



Versatile

- Evaluate the proofing properties of all types of yeast dough thanks to ability to customize the protocol.
- Study proofing properties for a period of up to 24 hours.

Simple

- Total control via PC software (USB connection).
- Fully automated testing: prepare the dough then leave the system to carry out the full analysis.
- Results backed up automatically.
- Automatic creation of analysis certificate.

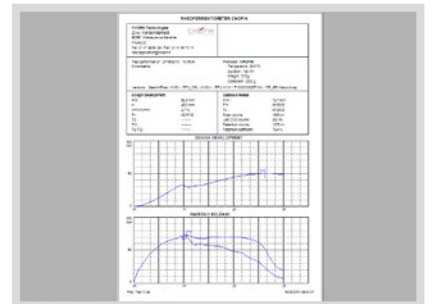

Ergonomic

- Lightweight compact device that will fit into your laboratory with ease.

Economical

- Simplified design, low maintenance, 1 single consumable (soda lime).